

Exposed Ratchet Type No. 00-R

Capacity: 1/8" through 1"

No. 111-R

Capacity: 1/8" through 1 1/4"

No. 12-R

Capacity: 1/8" through 2"

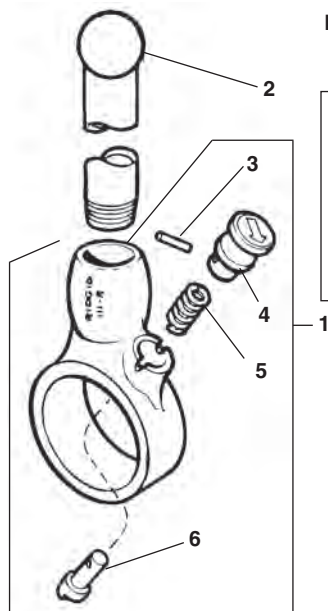

NOTE: Order parts by Catalog Number only.
DO NOT order by Reference Number.

Ref. No.	Description	00-R Catalog No.	111-R Catalog No.	12-R Catalog No.
—	Ratchet and Handle Assembly	38540	38550	—
1	Ratchet Assembly	38565	38575	12238
2	Handle	38590	38585	38585
3	Pin	38705	38705	38705
4	Knob	38700	38700	38700
5	Spring	16593	38695	38695
6	Pawl	38690	38690	38690

12-R Type 2 Ratchet and Handle

Ref. No.	Catalog No.	Description
—	30118	Ratchet & Handle Assembly
1	38585	Handle
2	12238	Ratchet Assembly
3	16033	Pawl
4	38695	Compression Spring
5	16023	Sleeve
6	16018	Spring Wave Washer
7	16038	Knob
8	38705	Pawl Pin

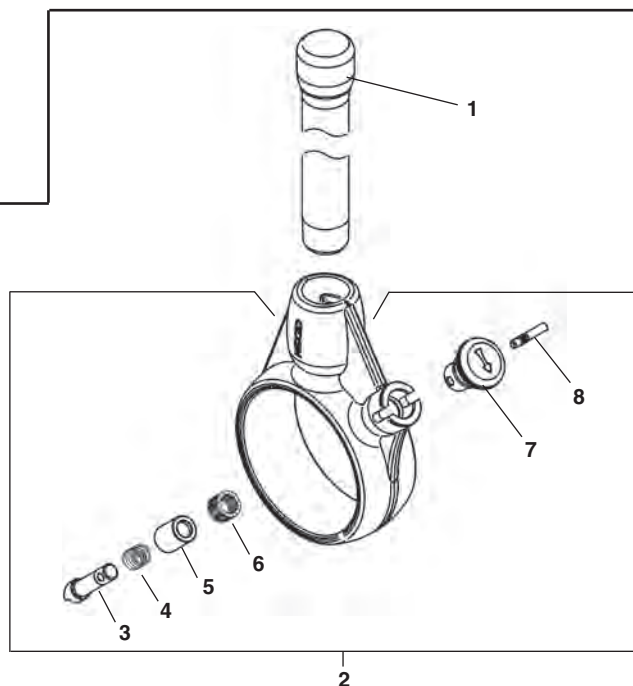

Die Head Assembly

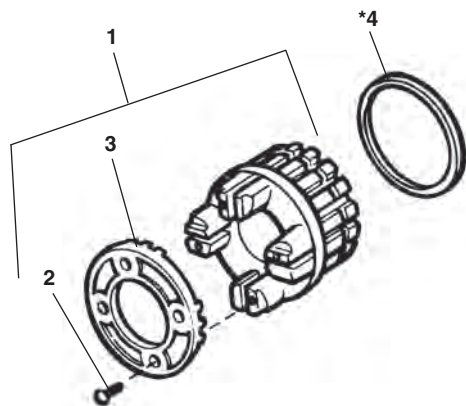

* Used on early models

Ref. No.	Description		00-R Catalog No.	12-R Catalog No.	12-R IMC Catalog No.
1	Die Head w/Cover Plate & Screws	1/8"	38710	38890	—
		1/4"	38730	38900	—
		3/8"	38740	38905	—
		1/2"	38755	38910	94060
		3/4"	38765	38915	94065
		1"	38775	38920	94070
		1 1/4"	—	38925	94075
		1 1/2"	—	38930	94080
2	Cover Plate Screw (4)	1/8"-1/4"	38720	38720	—
		3/8"-1 1/4"	38750	38750	38750
		1 1/2"-2"	—	38940	38940
3	Cover Plate	1/8"	38715	38715	—
		1/4"	38735	38735	—
		3/8"	38745	38745	—
		1/2"	38760	38760	38760
		3/4"	38770	38770	38770
		1"	38780	38780	38780
		1 1/4"	—	38880	38880
		1 1/2"	—	38935	38935
4	Spring Ring	—	—	38950	38950
			*38725	*38895	—